

● **CSCI 5304** ● **Fall 2018** ●

COMPUTATIONAL ASPECTS OF MATRIX THEORY

Class time : 8:15 – 9:30 TTh

Room : Keller Hall 3-115

Instructor : Yousef Saad

URL : www-users.cselabs.umn.edu/classes/Fall-2018/csci5304/

September 4, 2018

About this class. Instructor and Teaching Assistant

- Me: Yousef Saad
- TA: Sijie He

What you will learn and why

– Course title:

“Computational Aspects of Matrix Theory”

– Alternative title:

“Theoretical Aspects of Matrix Computations”

– Longer title:

“Everything you need to know about computations involving matrices that you can learn in one semester – from theory to algorithms, matlab implementations, and applications.”

- Topic becoming increasingly important in Computer Science.
- At the core of *most* disciplines requiring numerical computing.

Objectives of this course

Set 1 Fundamentals of matrix theory :

- Matrices, subspaces, eigenvectors
- Various decompositions, LU, QR, SVD, ..
- Norms, matrix norms, understanding errors, sensitivity [somewhat theoretical]

set 2 Computational linear algebra / Algorithms

- Solving linear systems, LU factorization
- Solving least-squares problems, QR factorization
- Eigenvalue problems - computing eigenvalues, eigenvectors,

Set 3 Linear algebra in applications

- See how numerical linear algebra is used to solve problems in (a few) computer science-related applications.
- e.g., page-rank, information retrieval, applications in machine learning, and in control, ..

Logistics:

➤ We will use Canvas only to post grades

➤ Main class web-site is :

`www-users.cselabs.umn.edu/classes/Fall-2018/
csci5304/`

➤ There you will find :

- Lecture notes
- Homeworks [and solutions]
- On occasion: Additional exercises [do before indicated class]
- ... and more

Please Note:

➤ Homeworks and solutions are copyrighted

● *Solutions of HWs and exams are provided to you [login required] with the hope of helping you understand the material better. By accessing them you agree not to send them to others, **sell them (%#!\$)**, or otherwise (help) make them available via external websites.*

Note: The login to access these solutions is **not** you U of M login. [it will be given in class later]

About lecture notes:

- Lecture notes (like this first set) will be posted on the class website – usually before the lecture. [Late? do not hesitate to send me e-mail]
- Note: format used in lectures may be formatted differently – but same contents.
- Review them to get some understanding if possible before class.
- Read the relevant section (s) in one of the references listed
- Lecture note sets are grouped by topics rather than by lecture.
- In the notes the symbol  indicates suggested easy exercises or questions – often [not always] done in class.

Occasional in-class practice exercises

- Posted in advance – see HWs web-page
- Do them before class. No need to turn in anything. But...
- ... prepare for an occasional follow-up Quiz [!relax: not graded]

Matlab

- You will need to use matlab for testing algorithms.
- No lecture notes on matlab +
- Other documents will be posted in the matlab web-site.
- Most important:
- .. I post the matlab **diaries** used for the demos (if any).

● If you do not know matlab at all and have difficulties with it see me or one of the TAs at office hours. All you may need is some initial help to get you started.

One final point on lecture notes

- These notes are 'evolving'. You can help make them better – report errors and provide feedback.
- Occasionally I will repost lecture notes with changes/additions [clearly indicated in red in the web-page]
- There will be much more going on in the classroom - so the notes are not enough for studying! Sometimes they are used as a summary.

➤ How to study for this course:

1) Rely primarily on lecture notes as a starting point. Use other sources [online books] to get a deeper understanding.

2) Do the practice exercises indicated in lecture notes + those occasionally posted in HW page.

3) Ask questions!

➤ Now: let us start!

GENERAL INTRODUCTION

- **Background: Linear algebra and numerical linear algebra**
- **Types of problems to be seen in this course**
- **Mathematical background - matrices, eigenvalues, rank, ...**
- **Types of matrices, structured matrices,**
- **Quick review of Matlab**
- **Vector norms, matrix norms**

Introduction

- This course is about *Matrix algorithms* or “matrix computations”
- It involves: algorithms for standard matrix computations (e.g. solving linear systems) - and their analysis (e.g., their cost, numerical behavior, ..)
- Matrix algorithms pervade most areas of science and engineering.
- In computer science: recent increase of interest in matrix algorithms for data mining, information retrieval, search engines, pattern recognition, graphics, ...

Examples

➤ Modern version of an old problem

A set of 12 coins containing nickels (5c each), dimes (10c each) and quarters (25c each) totals to \$1.45. In addition, the total without the nickels amounts to \$1.25. How many of each coin are there?

Solution: The system you get is

$$\begin{pmatrix} 5 & 10 & 25 \\ 1 & 1 & 1 \\ 0 & 10 & 25 \end{pmatrix} \begin{pmatrix} x_n \\ x_d \\ x_q \end{pmatrix} = \begin{pmatrix} 145 \\ 12 \\ 125 \end{pmatrix}$$

where $x_n = \#$ nickels, $x_d = \#$ dimes, $x_q = \#$ quarters

 And the solution is: ?

➤ Pagerank of Webpages (21st cent AD)

If one were to do a random walk from web page to web page, following each link on a given web page at random with equal likelihood, which are the pages to be encountered this way most often?

➤ Vibrations in mechanical systems. See:

www.cs.umn.edu/~saad/eig_book_2ndEd.pdf

Problem: Determine the vibration modes of the mechanical system [to avoid resonance]. See details in Chapter 10 (sec. 10.2) of above reference.

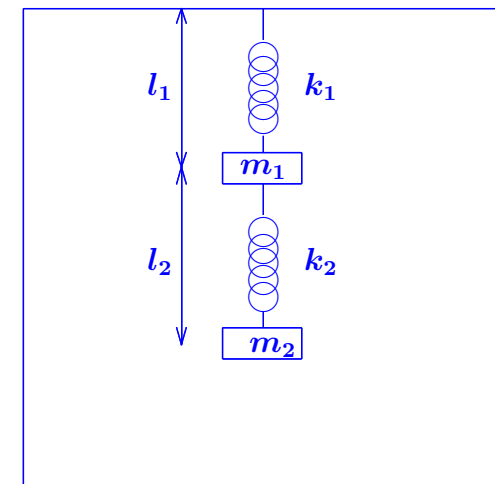

➤ Electrical circuits / Power networks, .. [Kirchhoff's voltage Law]

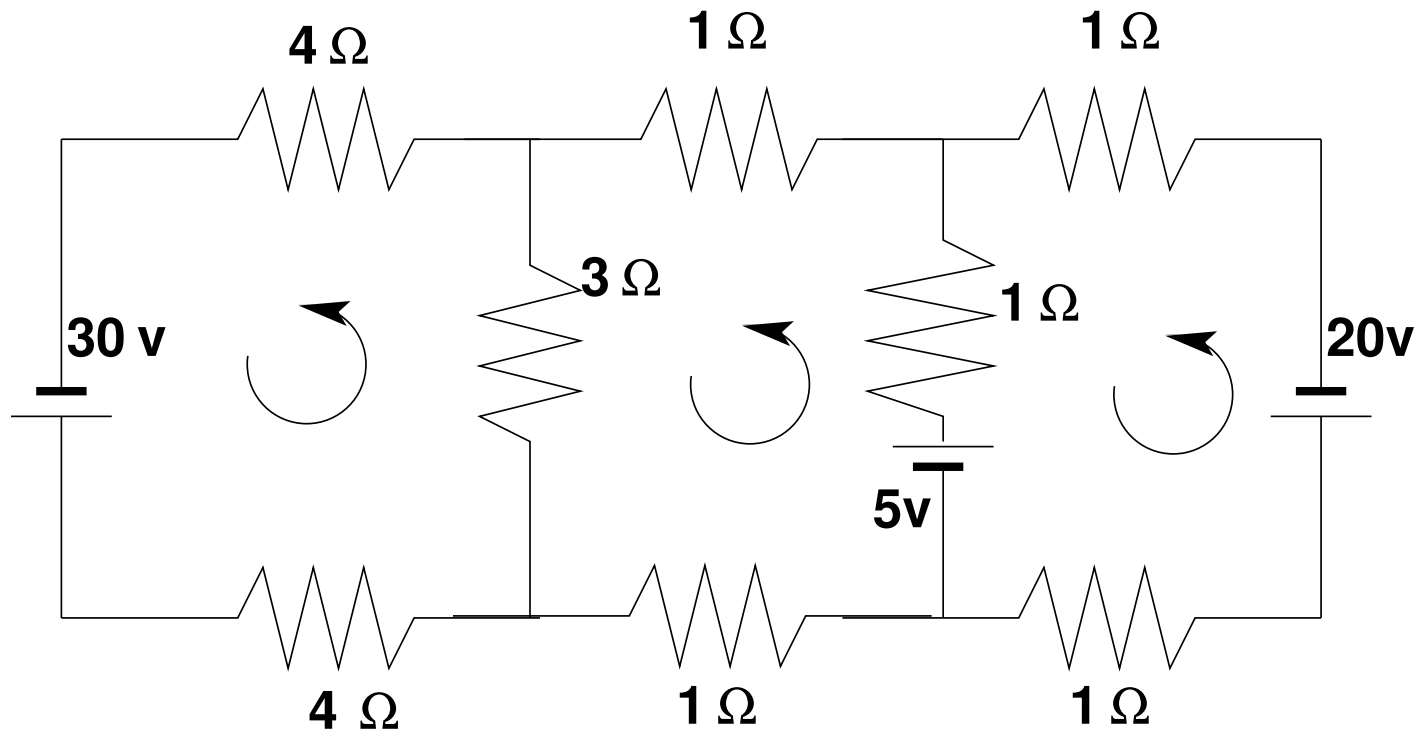

Problem: Determine the loop currents in a an electrical circuit - using Kirchhoff's Law ($V = RI$)

Examples (cont.)

- Method of least-squares (inspired by first use of least squares ever, by Gauss around 1801)

A planet follows an elliptical orbit according to $ay^2 + bxy + cx + dy + e = x^2$ in cartesian coordinates. Given a set of noisy observations of (x, y) positions, compute a, b, c, d, e , and use to predict future positions of the planet. This least squares problem is nearly rank-deficient and hence very sensitive to perturbations in the observations.

Read Wikipedia's article on planet ceres:

[http://en.wikipedia.org/wiki/Ceres_\(dwarf_planet\)](http://en.wikipedia.org/wiki/Ceres_(dwarf_planet))

Typical Large-scale problem (e.g. Fluid flow)

Physical Model



Nonlinear PDEs



Discretization



Linearization (Newton)



Sequence of Sparse Linear Systems $Ax = b$

Background in linear algebra

- Review vector spaces.
- A vector subspace of \mathbb{R}^n is a subset of \mathbb{R}^n that is also a real vector space. The set of all linear combinations of a set of vectors $G = \{a_1, a_2, \dots, a_q\}$ of \mathbb{R}^n is a vector subspace called the linear span of G ,
- If the a_i 's are linearly independent, then each vector of $\text{span}\{G\}$ admits a unique expression as a linear combination of the a_i 's. The set G is then called a *basis*.

 Recommended reading: Sections 1.1 – 1.6 of

www.cs.umn.edu/~saad/eig_book_2ndEd.pdf

Matrices

- A real $m \times n$ matrix A is an $m \times n$ array of real numbers

$$a_{ij}, \quad i = 1, \dots, m, \quad j = 1, \dots, n.$$

The set of all $m \times n$ matrices is a real vector space denoted by $\mathbb{R}^{m \times n}$.

- Complex matrices defined similarly.
- A matrix represents a linear mapping between two vector spaces of finite dimension n and m .

Operations:

Addition: $C = A + B$, where $A, B, C \in \mathbb{R}^{m \times n}$ and

$$c_{ij} = a_{ij} + b_{ij}, \quad i = 1, 2, \dots, m, \quad j = 1, 2, \dots, n.$$

Multiplication by a scalar: $C = \alpha A$, where

$$c_{ij} = \alpha a_{ij}, \quad i = 1, 2, \dots, m, \quad j = 1, 2, \dots, n.$$

Multiplication by another matrix:

$$C = AB,$$

where $A \in \mathbb{R}^{m \times n}$, $B \in \mathbb{R}^{n \times p}$, $C \in \mathbb{R}^{m \times p}$, and

$$c_{ij} = \sum_{k=1}^n a_{ik} b_{kj}.$$

Transposition: If $A \in \mathbb{R}^{m \times n}$ then its transpose is a matrix $C \in \mathbb{R}^{n \times m}$ with entries

$$c_{ij} = a_{ji}, i = 1, \dots, n, j = 1, \dots, m$$

Notation : A^T .

Transpose Conjugate: for complex matrices, the transpose conjugate matrix denoted by A^H is more relevant: $A^H = \bar{A}^T = \overline{A^T}$.

 $(A^T)^T = ??$

 $(AB)^T = ??$

 $(A^H)^H = ??$

 $(A^H)^T = ??$

 $(ABC)^T = ??$

 True/False: $(AB)C = A(BC)$

 True/False: $AB = BA$

 True/False: $AA^T = A^T A$

Review: Matrix-matrix and Matrix-vector products

- Recall definition of $C = A \times B$.
- Recall what C represents [in terms of mappings]..
- Can do the product column-wise [Matlab notation used]:





$$C_{:,j} = \sum_{k=1}^n b_{kj} A_{:,k}$$

- Can do it row-wise:

$$C_{i,:} = \sum_{k=1}^n a_{ik} B_{k,:}$$

- Can do it as a sum of 'outer-product' matrices:

$$C = \sum_{k=1}^n A_{:,k} B_{k,:}$$

-  Verify (prove) all 3 formulas above..
-  Complexity? [number of multiplications and additions]
-  What happens to these 3 different approaches when B has one column ($p = 1$)?
-  Characterize the matrices AA^T and $A^T A$ when A is of dimension $n \times 1$.

Range and null space (for $A \in \mathbb{R}^{m \times n}$)

- Range: $\text{Ran}(A) = \{Ax \mid x \in \mathbb{R}^n\} \subseteq \mathbb{R}^m$
- Null Space: $\text{Null}(A) = \{x \in \mathbb{R}^n \mid Ax = 0\} \subseteq \mathbb{R}^n$
- Range = linear span of the columns of A
- Rank of a matrix $\text{rank}(A) = \dim(\text{Ran}(A)) \leq n$
- $\text{Ran}(A) \subseteq \mathbb{R}^m \rightarrow \text{rank}(A) \leq m \rightarrow$
 $\text{rank}(A) \leq \min\{m, n\}$
- $\text{rank}(A) =$ number of linearly independent columns of $A =$ number of linearly independent rows of A
- A is of **full rank** if $\text{rank}(A) = \min\{m, n\}$. Otherwise it is **rank-deficient**.

Rank+Nullity theorem for an $m \times n$ matrix:

$$\dim(\text{Ran}(A)) + \dim(\text{Null}(A)) = n$$

Apply to A^T : $\dim(\text{Ran}(A^T)) + \dim(\text{Null}(A^T)) = m \rightarrow$

$$\text{rank}(A) + \dim(\text{Null}(A^T)) = m$$

➤ Terminology:

- $\dim(\text{Null}(A))$ is the **Nullity** of A

 Show that $A \in \mathbb{R}^{n \times n}$ is of rank one iff [if and only if] there exist two nonzero vectors u and v such that

$$A = uv^T.$$

What are the eigenvalues and eigenvectors of A ?

 Is it true that

$$\text{rank}(A) = \text{rank}(\bar{A}) = \text{rank}(A^T) = \text{rank}(A^H) ?$$

 Matlab exercise: explore the matlab function `rank`.

 Matlab exercise: explore the matlab function `rref`.

 Find the range and null space of the following matrix:

$$\begin{pmatrix} -1 & 1 & 0 \\ 1 & 2 & 3 \\ 1 & -2 & -1 \\ 2 & -1 & 1 \end{pmatrix}$$

Then verify your result with matlab.

Square matrices, matrix inversion, eigenvalues

➤ Square matrix: $n = m$ - so $A \in \mathbb{R}^{n \times n}$

➤ Identity matrix: square matrix with

$$a_{ij} = \begin{cases} 1 & \text{if } i = j \\ 0 & \text{otherwise} \end{cases}$$

➤ Notation: I .

➤ Property: $AI = IA = A$

➤ Inverse of A (when it exists) is a matrix C such that

$$AC = CA = I$$

Notation: A^{-1}

Eigenvalues and eigenvectors

A complex scalar λ is an **eigenvalue** of the square matrix A if a nonzero vector u of \mathbb{C}^n exists such that

$$Au = \lambda u.$$

The vector u is an **eigenvector** of A associated with λ . The set of all the eigenvalues of A is the **spectrum** of A . Notation: $\lambda(A)$.

- λ is an eigenvalue of A if and only if $\det(A - \lambda I) = 0$
- $p_A(\lambda) = \det(A - \lambda I)$ is a polynomial of degree n in $\lambda =$ characteristic polynomial of A .
- $\lambda \in \lambda(A)$ if and only if λ is a root of the characteristic polynomial $p_A(\lambda)$.

- Spectral radius = The maximum modulus of the eigenvalues

$$\rho(A) = \max_{\lambda \in \lambda(A)} |\lambda|.$$

- Trace of A = sum of diagonal elements of A .

$$\text{tr}(A) = \sum_{i=1}^n a_{ii}.$$

- $\text{tr}(A)$ = sum of all the eigenvalues of A counted with their multiplicities.

- Recall that $\det(A)$ = product of all the eigenvalues of A counted with their multiplicities.

- ☞ Trace, spectral radius, and determinant of

$$A = \begin{pmatrix} 2 & 1 \\ 3 & 0 \end{pmatrix}.$$

- ✍ For two $n \times n$ matrices A and B are the eigenvalues of AB and BA the same?
- ✍ If A is nonsingular what are the eigenvalues/eigenvectors of A^{-1} ?
- ✍ What are the eigenvalues/eigenvectors of A^k for a given integer power k ?
- ✍ What are the eigenvalues/eigenvectors of $p(A)$ for a polynomial p ?
- ✍ Review the Jordan canonical form. Define the eigenvalues, and eigenvectors from the Jordan form.

Types of (square) matrices







- Symmetric $A^T = A$.
- Hermitian $A^H = A$.
- Normal $A^H A = A A^H$.
- Nonnegative $a_{ij} \geq 0, i, j = 1, \dots, n$
- Similarly for nonpositive, positive, and negative matrices
- Unitary $Q^H Q = I$. (for complex matrices)
- Skew-symmetric $A^T = -A$.
- Skew-Hermitian $A^H = -A$.

[Note: Common useage restricts this definition to complex matrices.
An orthogonal matrix is a unitary real matrix – not very natural]

- **Orthogonal** $Q^T Q = I$ [orthonormal columns]

[I will sometimes call unitary matrix a square matrix with orthonormal columns, regardless on whether it is real or complex]

➤ The term “orthonormal” matrix is rarely used.

-  What is the inverse of a unitary (complex) or orthogonal (real) matrix?
-  What can you say about the diagonal entries of a skew-symmetric (real) matrix?
-  What can you say about the diagonal entries of a Hermitian (complex) matrix?
-  What can you say about the diagonal entries of a skew-Hermitian (complex) matrix?
-  The following types of matrices are normal [true-false]: real symmetric, real skew-symmetric, complex Hermitian, complex skew-Hermitian.
-  Find all **real** 2×2 matrices that are normal.
-  Show that any triangular matrix that is normal is diagonal

Matrices with structure

- Diagonal $a_{ij} = 0$ for $j \neq i$. Notation :

$$A = \text{diag} (a_{11}, a_{22}, \dots, a_{nn}) .$$

- Upper triangular $a_{ij} = 0$ for $i > j$.
- Lower triangular $a_{ij} = 0$ for $i < j$.
- Upper bidiagonal $a_{ij} = 0$ for $j \neq i$ or $j \neq i + 1$.
- Lower bidiagonal $a_{ij} = 0$ for $j \neq i$ or $j \neq i - 1$.
- Tridiagonal $a_{ij} = 0$ when $|i - j| > 1$.



- **Banded** $a_{ij} \neq 0$ only when $i - m_l \leq j \leq i + m_u$, 'Bandwidth' = $m_l + m_u + 1$.
- **Upper Hessenberg** $a_{ij} = 0$ when $i > j + 1$. Lower Hessenberg matrices can be defined similarly.
- **Outer product** $A = uv^T$, where both u and v are vectors.
- **Block tridiagonal** generalizes tridiagonal matrices by replacing each nonzero entry by a square matrix.

Special matrices

Vandermonde :

- Given a column of entries $[x_0, x_1, \dots, x_n]^T$ put its (component-wise) powers into the columns of a matrix V :

$$V = \begin{pmatrix} 1 & x_0 & x_0^2 & \cdots & x_0^n \\ 1 & x_1 & x_1^2 & \cdots & x_1^n \\ \vdots & \vdots & \vdots & \ddots & \vdots \\ 1 & x_n & x_n^2 & \cdots & x_n^n \end{pmatrix}$$

-  Try the matlab function *vander*
-  What does the matrix-vector product Va represent?
-  Interpret the solution of the linear system $Va = y$ where a is the unknown. Sketch a 'fast' solution method based on this.

Toeplitz :

- Entries are constant along diagonals, i.e., $a_{ij} = r_{j-i}$.
- Determined by $m + n - 1$ values r_{j-i} .

$$T = \underbrace{\begin{pmatrix} r_0 & r_1 & r_2 & r_3 & r_4 \\ r_{-1} & r_0 & r_1 & r_2 & r_3 \\ r_{-2} & r_{-1} & r_0 & r_1 & r_2 \\ r_{-3} & r_{-2} & r_{-1} & r_0 & r_1 \\ r_{-4} & r_{-3} & r_{-2} & r_{-1} & r_0 \end{pmatrix}}_{\text{Toeplitz}}$$

- Toeplitz systems ($m = n$) can be solved in $O(n^2)$ ops.
- The whole inverse (!) can be determined in $O(n^2)$ ops.

 Explore $\text{toeplitz}(c,r)$ in matlab.



Hankel: Entries are constant along anti-diagonals, i.e., $a_{ij} = h_{j+i-1}$.
Determined by $m + n - 1$ values h_{j+i-1} .

$$H = \underbrace{\begin{pmatrix} h_1 & h_2 & h_3 & h_4 & h_5 \\ h_2 & h_3 & h_4 & h_5 & h_6 \\ h_3 & h_4 & h_5 & h_6 & h_7 \\ h_4 & h_5 & h_6 & h_7 & h_8 \\ h_5 & h_6 & h_7 & h_8 & h_9 \end{pmatrix}}_{Hankel}$$

 Explore $hankel(c,r)$ in matlab.

Circulant : Entries in a row are cyclically right-shifted to form next row. Determined by n values.

$$C = \underbrace{\begin{pmatrix} v_1 & v_2 & v_3 & v_4 & v_5 \\ v_5 & v_1 & v_2 & v_3 & v_4 \\ v_4 & v_5 & v_1 & v_2 & v_3 \\ v_3 & v_4 & v_5 & v_1 & v_2 \\ v_2 & v_3 & v_4 & v_5 & v_1 \end{pmatrix}}_{\text{Circulant}}$$

-  How can you generate a circulant matrix in matlab?
-  If C is circulant (real) and symmetric, what can be said about the v_i 's?

Sparse matrices

- Matrices with very few nonzero entries – so few that this can be exploited.
- Many of the large matrices encountered in applications are sparse.
- Main idea of “sparse matrix techniques” is not to represent the zeros.
- This will be covered in some detail at the end of the course.